

AMMC-6345

20-45 GHz Driver Amplifier

Description



Lifecycle status: **Active**

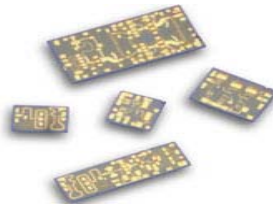

Features

Wide Frequency Range: 20-45 GHz

High Gain: 20 dB

Power: @40 GHz, P-1dB=24 dBm

High linear: OIP3=32 dBm

Integrated RF Power Detector

5.0v, -0.7v, 480mA operation

Applications

Microwave Radio Systems

Satellite VSAT and DBS systems

LMDS and Point-to-Point Millimeter Wave Long Haul Platforms

802.16 & 802.20 WiMax BWA

WLL and MMDS Loops

Commercial grade military

Can be driver amplifier for the AMMC-64xx power amplifiers

Data Sheet

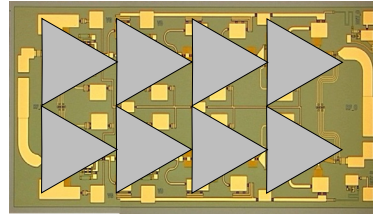

Chip Size: 2500 x 1150 μm (100 x 45 mils)
Chip Size Tolerance: $\pm 10\mu\text{m}$ (± 0.4 mils)
Chip Thickness: 100 $\pm 10\mu\text{m}$ (4 ± 0.4 mils)
Pad Dimensions: 100 x 100 μm (4 ± 0.4 mils)

Description

The AMMC-6345 MMIC is a broadband medium power amplifier designed for use in driving stage for transmitters that operate in various frequency bands between 20GHz and 45GHz. It can be used as a driver stage for the AMMC-6425, 6430 and 6440 (18-27GHz, 25-32GHz and 37-42GHz) 1W MMIC power amplifiers when linear operation is required. At 40GHz, it provides 24dBm of output power (P-1dB), 20dB of gain, and a 32 dBm output third order intercept (OIP3). The device has input and output matching circuitry for use in 50 Ω environments. The AMMC-6345 integrates a temperature compensated RF power detection circuit that enables power detection of 0.8V/W at 40GHz. The device operates on 5V for current supply (negative voltage only needed for Vg). It is fabricated in a PHEMT process for exceptional power and gain performance. For improved reliability and moisture protection, the die is passivated at the active areas.

Features

- Wide frequency range: 20 - 45 GHz
- High gain: 20 dB
- Power: @40 GHz, P-1dB=24 dBm
- Highly linear: OIP3=32dBm
- Integrated RF power detector
- 5.0 Volt, -0.55 Volt, 480mA operation

Applications

- Microwave Radio systems
- Satellite VSAT and DBS systems
- LMDS & Pt-Pt mmW Long Haul
- 802.16 & 802.20 WiMax BWA
- WLL and MMDS loops
- Can be driver amplifier for the AMMC-64xx power amplifiers

AMMC-6345 Absolute Maximum Ratings^[1]

Symbol	Parameters/Conditions	Units	Min.	Max.
V _d	Positive Drain Voltage	V		7
V _g	Gate Supply Voltage	V	-3	0.5
I _d	Drain Current	mA		700
P _{in}	CW Input Power	dBm		23
T _{ch}	Operating Channel Temp.	°C		+150
T _{stg}	Storage Case Temp.	°C	-65	+150
T _{max}	Maximum Assembly Temp (60 sec max)	°C		+300

Note:

1. Operation in excess of any one of these conditions may result in permanent damage to this device.



NOTE: THESE DEVICES ARE ESD SENSITIVE. THE FOLLOWING PRECAUTIONS ARE STRONGLY RECOMMENDED. ENSURE THAT AN ESD APPROVED CARRIER IS USED WHEN DICE ARE TRANSPORTED FROM ONE DESTINATION TO ANOTHER. PERSONAL GROUNDING IS TO BE WORN AT ALL TIMES WHEN HANDLING THESE DEVICES

AMMC-6345 DC Specifications/Physical Properties [1]

Symbol	Parameters and Test Conditions	Units	Min.	Typ.	Max.
I_d	Drain Supply Current (under any RF power drive and temperature) ($V_d=5.0V$, V_g set for I_d typical)	mA		480	600
V_g	Gate Supply Operating Voltage $I_{d(Q)} = 480mA$	V	-0.75	-0.55	-0.4
V_p	Pinch-off voltage ($V_{dd}=2.5V$, $I_{ds}=20mA$)	V		-1.2	
θ_{ch-b}	Thermal Resistance [2] Backside temperature, $T_b=25^\circ C$	$^\circ C/W$		8.2	

Notes:

1. Ambient operational temperature $T_A=25^\circ C$ unless otherwise noted.
2. Channel-to-backside Thermal Resistance (θ_{ch-b}) = $9.0^\circ C/W$ at $T_{channel} (T_c) = 70^\circ C$ as measured using infrared microscopy. Thermal Resistance at backside temperature (T_b) = $25^\circ C$ calculated from measured data.

AMMC-6345 RF Specifications [3, 4] ($T_A=25^\circ C$, $V_d=5V$, $I_{d(Q)}=480 mA$, $Z_0=50 \Omega$)

Symbol	Parameters and Test Conditions	Units	Minimum	Typical	Maximum	Sigma
Gain	Small-signal Gain[4]	dB	18			0.28
P_{-1dB}	Output Power at 1dB Gain Compression	dBm	22.5	24		0.20
P_{-3dB}	Output Power at 3dB Gain Compression	dBm		25		0.17
OIP3	Third Order Intercept Point; $\Delta f=100MHz$; $P_{in}=-20dBm$	dBm		32		0.8
RLin	Input Return Loss[4]	dB		-17		0.92
RLout	Output Return Loss[4]	dB		-13		0.63
Isolation	Min. Reverse Isolation	dB		-40		1.30

Notes:

3. Small/Large -signal data measured in wafer form $T_A = 25^\circ C$.
4. 100% on-wafer RF test is done at frequency = 25, 30, and 38 GHz. Statistics based on 1500 part sample

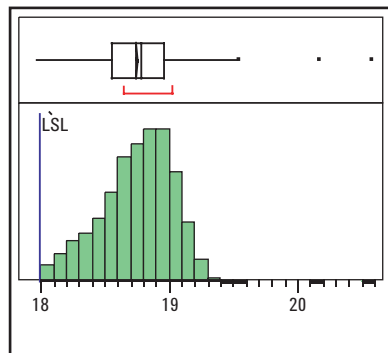

Gain at 30 GHz

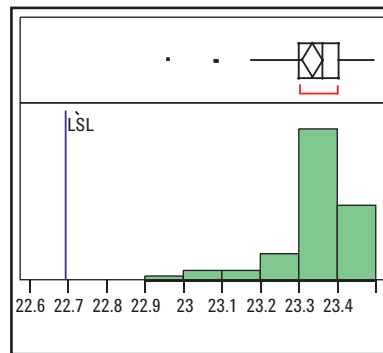

P-1dB at 30 GHz

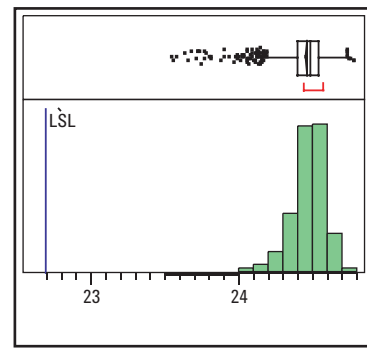

P-1dB at 38 GHz

Typical distribution of Small Signal Gain and Output Power @P-1dB. Based on 1500 part sampled over several production lots.

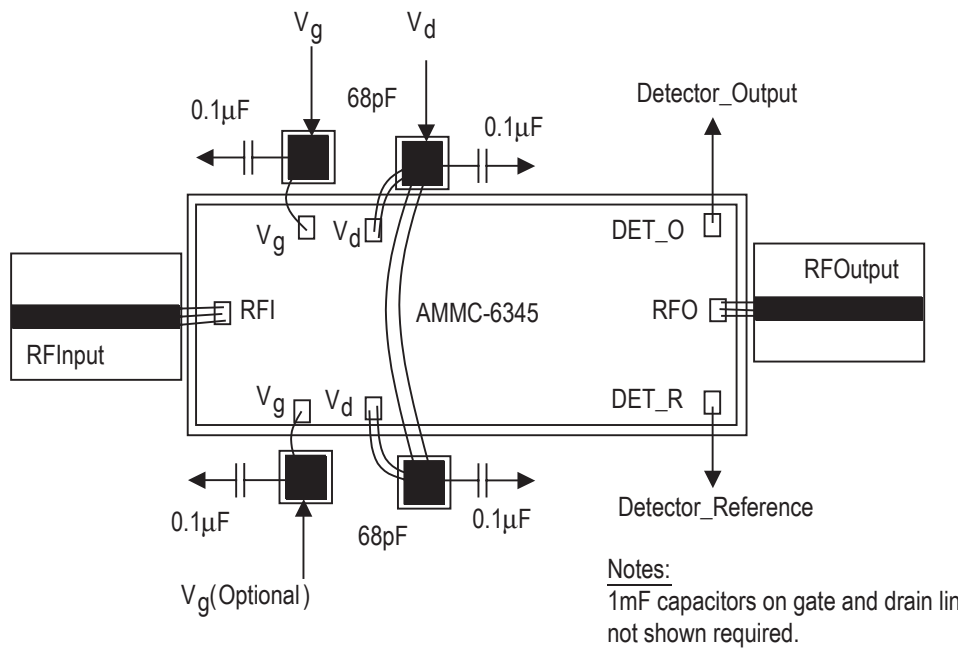

Figure 13. AMMC-6345 Assembly diagram

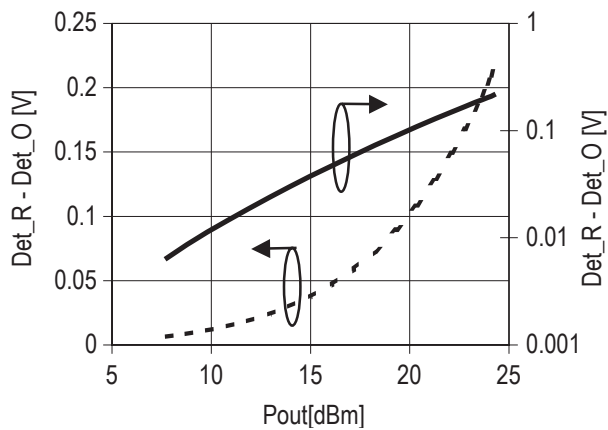

Figure 14. AMMC-6345 Typical Detector Voltage and Output Power, Freq=40 GHz

Ordering Information:

AMMC-6345-W10 = 10 devices per tray

AMMC-6345-W50 = 50 devices per tray